

FEATURES

- 1140V P-P SIGNAL OUTPUT
- WIDE SUPPLY RANGE — ±75V to ±600V
- PROGRAMMABLE CURRENT LIMIT
- 75 mA CONTINUOUS OUTPUT CURRENT
- HERMETIC SEALED PACKAGE
- INPUT PROTECTION

APPLICATIONS

- PIEZOELECTRIC POSITIONING
- HIGH VOLTAGE INSTRUMENTATION
- ELECTROSTATIC DEFLECTION
- SEMICONDUCTOR TESTING

DESCRIPTION

The PA89 is an ultra high voltage, MOSFET operational amplifier designed for output currents up to 75 mA. Output voltages can swing over 1000V p-p. The safe operating area (SOA) has no second breakdown limitations and can be observed with all types of loads by choosing an appropriate current limiting resistor. High accuracy is achieved with a cascode input circuit configuration and 120dB open loop gain. All internal biasing is referenced to a bootstrapped zener-MOSFET current source, giving the PA89 a wide supply range and excellent supply rejection. The MOSFET output stage is biased for class A/B linear operation. External compensation provides user flexibility. The PA89 is 100% gross leak tested to military standards for long term reliability.

This hybrid integrated circuit utilizes a beryllia (BeO) substrate, thick film resistors, ceramic capacitors and semiconductor chips to maximize reliability, minimize size and give top performance. Ultrasonically bonded aluminum wires provide reliable interconnections at all operating temperatures. The MO-127 High Voltage, Power Dip™ package is hermetically sealed and electrically isolated. The use of compressible thermal washers will void the product warranty.

SIMPLIFIED SCHEMATIC

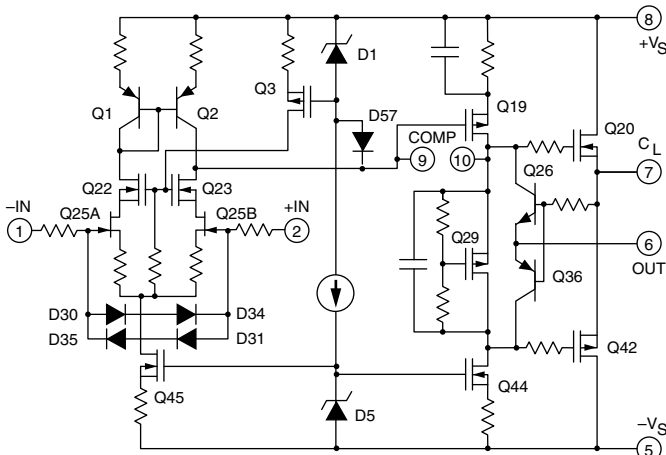

PATENTED

HIGH VOLTAGE MO-127 PACKAGE STYLE DC

TYPICAL APPLICATION

Ultra-high voltage capability combined with the bridge amplifier configuration makes it possible to develop +/-1000 volt peak swings across a piezo element. A high gain of -50 for A1 insures stability with the capacitive load, while "noise-gain" compensation Rn and Cn on A2 insure the stability of A2 by operating in a noise gain of 50.

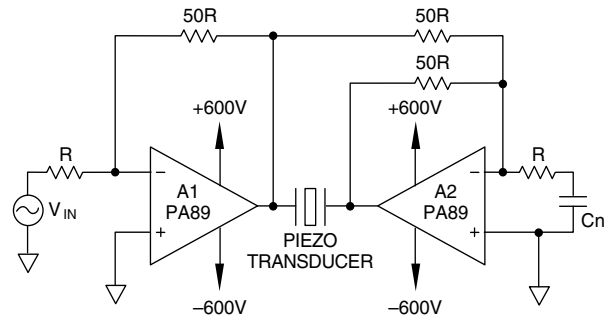

SINGLE AXIS MICRO-POSITIONING

EXTERNAL CONNECTIONS

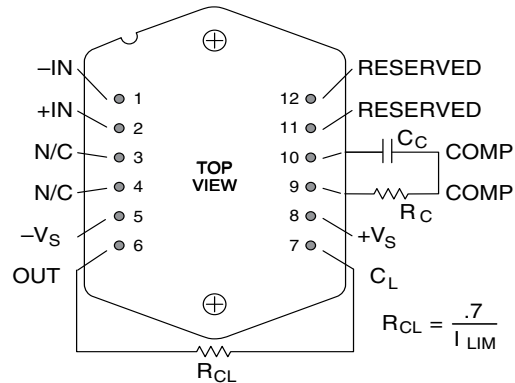

PHASE COMPENSATION

Gain	C _c	R _c
1	470pF	470Ω
10	68pF	220Ω
15	33pF	220Ω
100	15pF	220Ω

Note: C_c must be rated for full supply voltage -Vs to +Vs. See details under "EXTERNAL COMPONENTS".

ABSOLUTE MAXIMUM RATINGS

SUPPLY VOLTAGE, +V _S to -V _S	1200V
OUTPUT CURRENT, within SOA	100mA
POWER DISSIPATION, internal at T _C = 25°C	40W
INPUT VOLTAGE, differential	±25V
INPUT VOLTAGE, common mode	±V _S ±25V
TEMPERATURE, pin solder - 10s max	300°C
TEMPERATURE, junction ²	150°C
TEMPERATURE, storage	-65 to 125°C
OPERATING TEMPERATURE RANGE, case	-55 to 125°C

SPECIFICATIONS

PARAMETER	TEST CONDITIONS ¹	PA89			PA89A			UNITS
		MIN	TYP	MAX	MIN	TYP	MAX	
INPUT								
OFFSET VOLTAGE, initial			.5	2		.25	.5	mV
OFFSET VOLTAGE, vs. temperature	Full temperature range		10	30		5	10	μV/°C
OFFSET VOLTAGE, vs. supply			7			*		μV/V
OFFSET VOLTAGE, vs. time			75			*		μV/kh
BIAS CURRENT, initial ³			5	50		3	10	pA
BIAS CURRENT, vs. supply			.01			*		pA/V
OFFSET CURRENT, initial ³			5	50		3	20	pA
INPUT IMPEDANCE, DC			10 ⁵			*		MΩ
INPUT CAPACITANCE			4			*		pF
COMMON MODE VOLTAGE RANGE ⁴	Full temperature range	±V _S ±50			*			V
COMMON MODE REJECTION, DC	Full temperature range, V _{CM} = ±90V	96	110		*	*		dB
INPUT NOISE	10kHz BW, R _S = 10K, C _C = 15pF		4					μV RMS
GAIN								
OPEN LOOP GAIN at 10Hz	R _L = 10k, C _C = 15pF	108	120		*	*		dB
GAIN BANDWIDTH PRODUCT	R _L = 10k, C _C = 15pF, A _V = 100		10			*		MHz
POWER BANDWIDTH	R _L = 10k, C _C = 15pF, V _O = 500V p-p		5			*		kHz
PHASE MARGIN	Full temperature range, A _V = 10		60			*		°
OUTPUT								
VOLTAGE SWING ⁴	I _O = 75mA	±V _S ±45	±V _S ±30		*	*		V
VOLTAGE SWING ⁴	Full temperature range, I _O = 20mA	±V _S ±20	±V _S ±12		*	*		V
CURRENT, continuous	Full temperature range	75			*	*		mA
SLEW RATE	C _C = 15pF, A _V = 100	12	16		*	*		V/μs
CAPACITIVE LOAD, A _V = 10	Full temperature range			1			*	nF
CAPACITIVE LOAD, A _V > 10	Full temperature range			SOA			*	
SETTLING TIME to .1%	R _L = 10KΩ, 10V step, A _V = 10		2			*		μs
POWER SUPPLY								
VOLTAGE, V _S ⁴	Full temperature range	±75	±500	±600	*	*	*	V
CURRENT, quiescent			4.8	6.0		*	*	mA
THERMAL								
RESISTANCE, AC, junction to case ⁵	Full temperature range, F > 60Hz		2.1	2.3		*	*	°C/W
RESISTANCE, DC, junction to case	Full temperature range, F < 60Hz		3.3	3.5		*	*	°C/W
RESISTANCE, junction to air	Full temperature range		15			*	*	°C/W
TEMPERATURE RANGE, case	Meets full range specifications	-25		+85	*		*	°C

- NOTES: * The specification of PA89A is identical to the specification for PA89 in applicable column to the left.
1. Unless otherwise noted: T_C = 25°C, C_C = 68pF, R_C = 220Ω, and V_S = ±500V. Input parameters for bias currents and offset voltage are ± values given.
 2. Long term operation at the maximum junction temperature will result in reduced product life. Derate internal power dissipation to achieve high MTTF.
 3. Doubles for every 10°C of temperature increase.
 4. +V_S and -V_S denote the positive and negative supply rail respectively.
 5. Rating applies only if the output current alternates between both output transistors at a rate faster than 60Hz.

CAUTION

The PA89 is constructed from MOSFET transistors. ESD handling procedures must be observed. The internal substrate contains beryllia (BeO). Do not break the seal. If accidentally broken, do not crush, machine, or subject to temperatures in excess of 850°C to avoid generating toxic fumes.

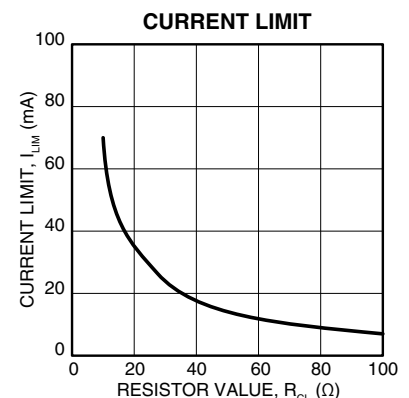
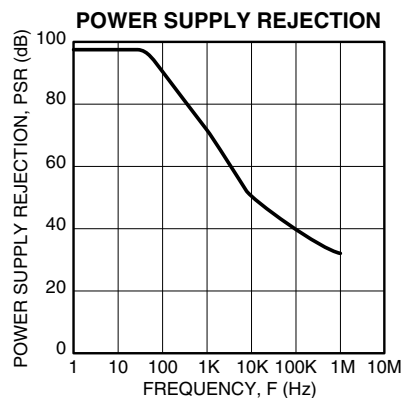
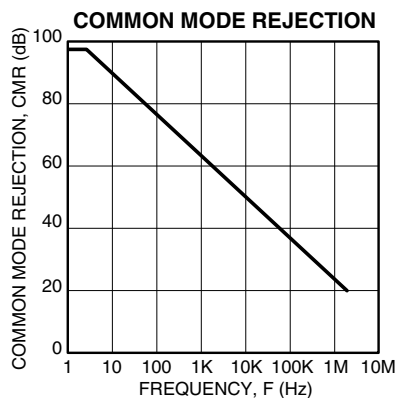
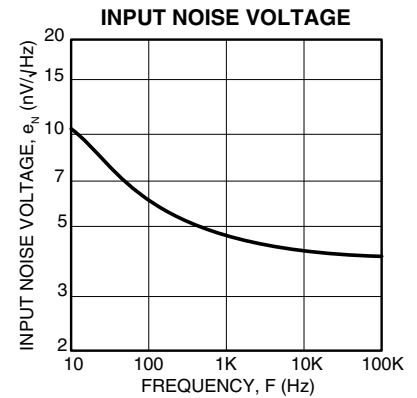
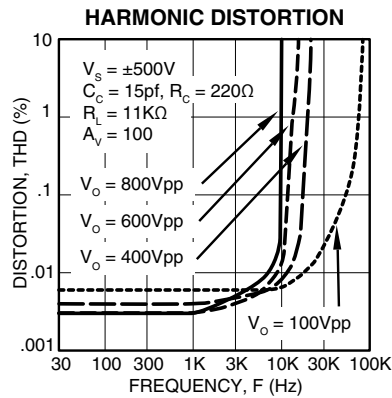
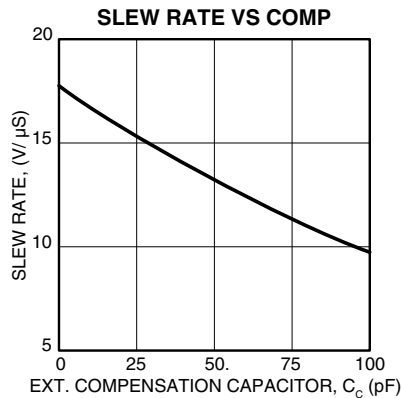
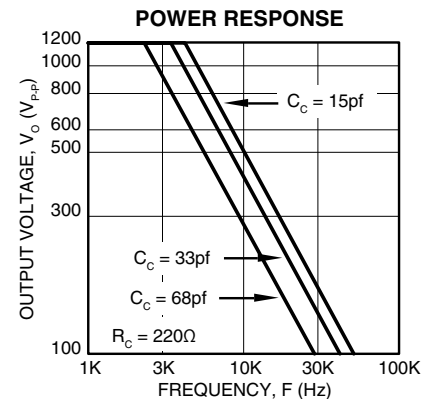
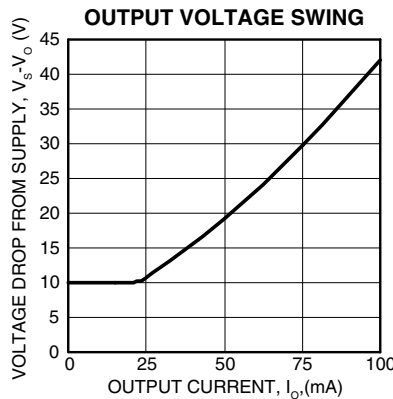
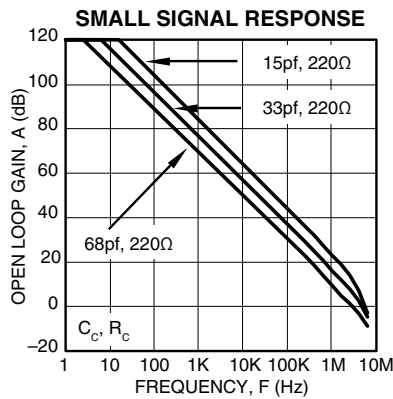
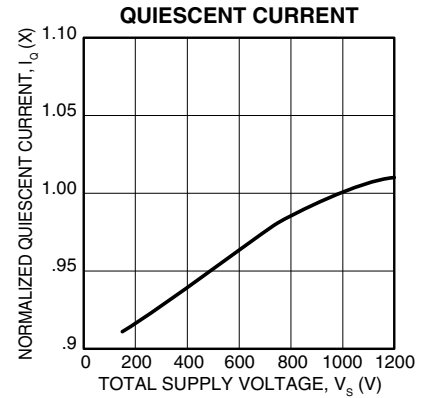
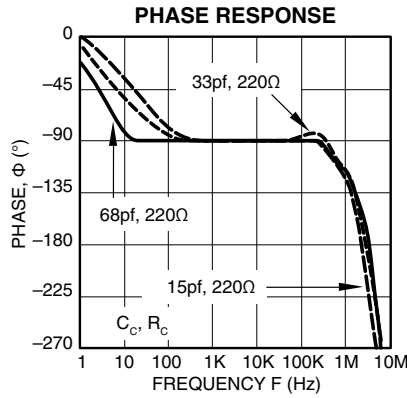
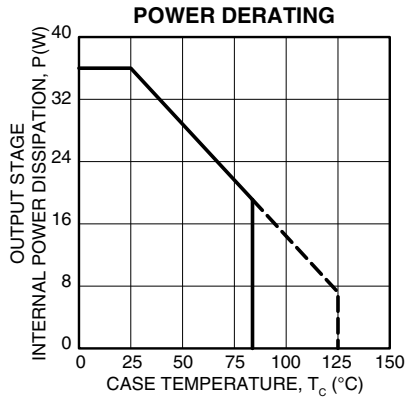

GENERAL

Please read Application Note 1 "General Operating Considerations" which covers stability, supplies, heat sinking, mounting, current limit, SOA interpretation, and specification interpretation. Visit www.apexmicrotech.com for design tools that help automate tasks such as calculations for stability, internal power dissipation, current limit; heat sink selection; Apex's complete Application Notes library; Technical Seminar Workbook; and Evaluation Kits.

STABILITY

Although the PA89 can be operated at unity gain, maximum slew rate and bandwidth performance was designed to be obtained at gains of 10 or more. Use the small signal response and phase response graphs as a guide. In applications where gains of less than 10 are required, use noise gain compensation to increase the phase margin of the application circuit as illustrated in the typical application drawing.

SAFE OPERATING AREA (SOA)

The MOSFET output stage of this power operational amplifier has two distinct limitations:

1. The current handling capability of the MOSFET geometry and the wire bonds.
2. The junction temperature of the output MOSFETs.

NOTE: The output stage is protected against transient flyback. However, for protection against sustained, high energy flyback, external fast-recovery diodes should be used.

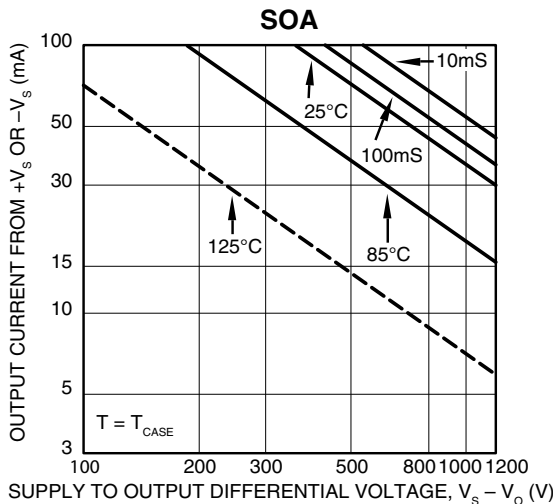

SAFE OPERATING CURVES

The safe operating area curves define the maximum additional internal power dissipation the amplifier can tolerate when it produces the necessary output to drive an external load. This is not the same as the absolute maximum internal power dissipation listed elsewhere in the specification since the quiescent power dissipation is significant compared to the total.

EXTERNAL COMPONENTS

The very high operating voltages of the PA89 demand consideration of two component specifications rarely of con-

cern in building op amp circuits: voltage rating and voltage coefficient.

The compensation capacitance C_c must be rated for the full supply voltage range. For example, with supply voltages of $\pm 500V$ the possible voltage swing across C_c is 1000V. In addition, a voltage coefficient less than 100PPM is recommended to maintain the capacitance variation to less than 5% for this example. It is strongly recommended to use the highest quality capacitor possible rated at least twice the total supply voltage range.

Of equal importance are the voltage rating and voltage coefficient of the gain setting resistances. Typical voltage ratings of low wattage resistors are 150 to 250V. In the above example 1000V could appear across the feedback resistor. This would require several resistors in series to obtain the proper voltage rating. Low voltage coefficient resistors will insure good gain linearity. The wattage rating of the feedback resistor is also of concern. A 1 megohm feedback resistor could easily develop 1 watt of power dissipation.

Though high voltage rated resistors can be obtained, a 1 megohm feedback resistor comprised of five 200Kohm, 1/4 watt metal film resistors in series will produce the proper voltage rating, voltage coefficient and wattage rating.

CURRENT LIMIT

For proper operation the current limit resistor (R_{CL}) must be connected as shown in the external connection diagram. The minimum value is 3.5 ohm, however for optimum reliability the resistor value should be set as high as possible. The value is calculated as follows with the maximum practical value of 150 ohms.

$$R_{CL} = \frac{.7}{I_{LIM}}$$

When setting the value for R_{CL} allow for the load current as well as the current in the feedback resistor. Also allow for the temperature coefficient of the current limit which is approximately $-0.3\%/^{\circ}C$ of case temperature rise.

CAUTIONS

The operating voltages of the PA89 are potentially lethal. During circuit design, develop a functioning circuit at the lowest possible voltages. Clip test leads should be used for "hands off" measurements while troubleshooting.

POWER SUPPLY PROTECTION

Unidirectional zener diode transient absorbers are recommended as protection on the supply pins. The zeners clamp transients to voltages within the power supply rating and also clamp power supply reversals to ground. Whether the zeners are used or not, the system power supply should be evaluated for transient performance including power-on overshoot and power-off polarity reversals as well as line regulation.

Conditions which can cause open circuits or polarity reversals on either power supply rail should be avoided or protected against. Reversals or opens on the negative supply rail is known to induce input stage failure. Unidirectional transzorbs prevent this, and it is desirable that they be both electrically and physically as close to the amplifier as possible.